

The background of the image is a dense, repeating pattern of light gray technical drawings of various Renault engine components, including pistons, valves, and cylinder heads, arranged in a grid-like fashion.

RENAULT



C.C. 845

1

HG6540010SB

RENAULT

HG6540010SB

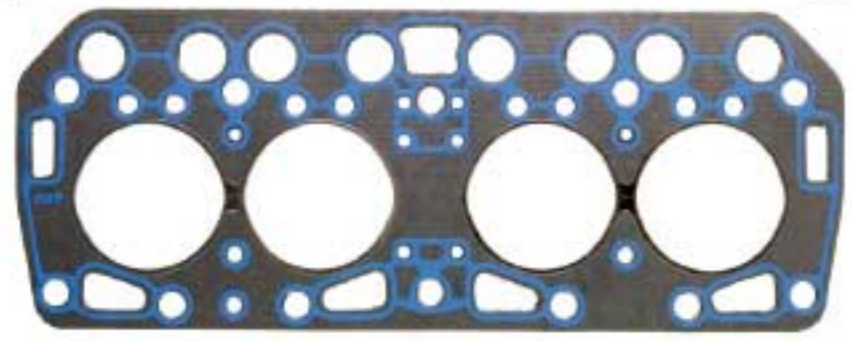

Gasolina

Calibre 1.6 mm.

CULATA

TAPA VÁLVULAS

CÁRTER

MÚLT. ADMISIÓN

MÚLT. ESCAPE

VS6540010

OS6540010

MS6540010

N/D

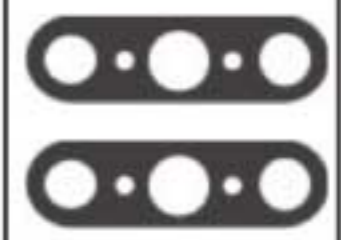

MODELO

MOTOR

PISTON

AÑOS

R4

800

Ø 58.00 mm.

1960 / 1986

DISTRIBUCIÓN

RETENEDORES

TUBO DE ESCAPE

N/D

N/D

SELLOS DE VÁLVULA

Empaques Adicionales



LOS PRODUCTOS CON REFERENCIA SON DE VENTA POR SEPARADO



C.C. 956

2

FW6540030

RENAULT

HG6540030SB

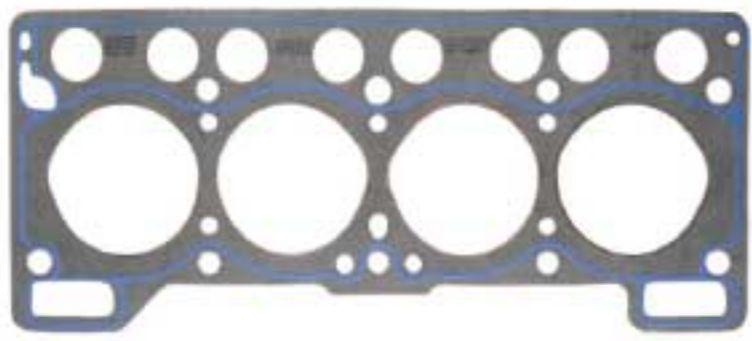

Gasolina

Calibre 1.3 mm.

CULATA

TAPA VÁLVULAS

CÁRTER

MÚLT. ADMISIÓN

MÚLT. ESCAPE

VS6540030

OS6540030

MS6540030

N/D

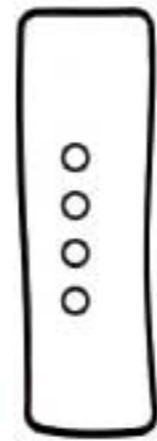

MODELO

MOTOR

PISTON

AÑOS

R5
R6

688
688

Ø 69.00 mm.

1972 / 1975
1968 / 1970

DISTRIBUCIÓN

RETENEDORES

TUBO DE ESCAPE

N/D

N/D



SELLOS DE VÁLVULA

Empaques Adicionales





C.C. 999

3

FS6530035ELRING

RENAULT

HG6530035MLO



CULATA TAPA VÁLVULAS CÁRTER MÚLT. ADMISIÓN MÚLT. ESCAPE

VS6530035

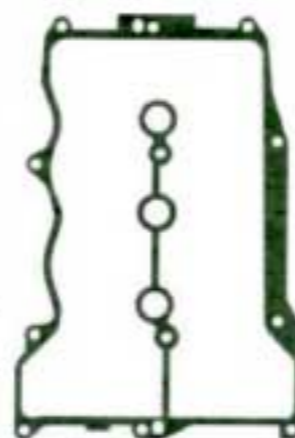

OS6530035

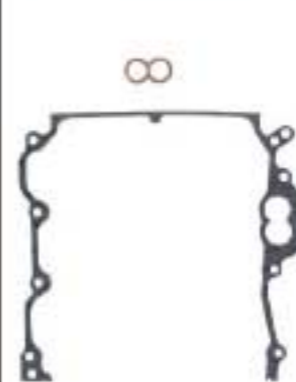

MI6530035



ME6530035



Gasolina

Otras Juntas de Culata disponibles / HG6530035MLO / 910.034

MODELO	MOTOR	PISTON	AÑOS
KWID	B4D	Ø 71.00 mm.	2019 / 2023

DISTRIBUCIÓN

TW6530035



RETENEDORES



Distribución
40*52*6.9

Eje de levas



Cigüeñal
69*89*9

TUBO DE ESCAPE

N/D

SELLOS DE VÁLVULA

Empaques Adicionales





C.C. 999

4

FS6530035NRELRING

RENAULT

HG6530035NR



CULATA TAPA VÁLVULAS CÁRTER MÚLT. ADMISIÓN MÚLT. ESCAPE

VS6530035

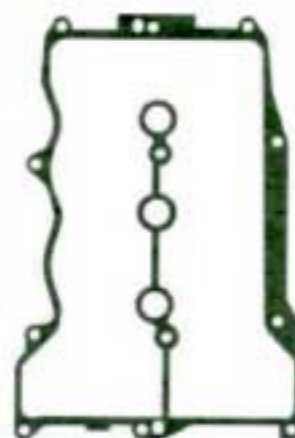

OS6530035

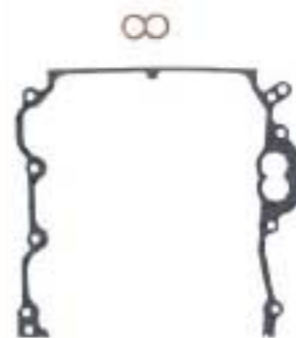

MI6530035



ME6530035



Gasolina

Calibre 1.0 mm.

Otras Juntas de Culata disponibles / HG6530035MLO / 910.034

MODELO	MOTOR	PISTON	AÑOS
KWID	B4D	Ø 71.00 mm.	2019 / 2023

DISTRIBUCIÓN

TW6530035



RETENEDORES



Distribución
40*52*6.9

Eje de levas



Cigüeñal
69*89*9

TUBO DE ESCAPE

N/D

SELLOS DE VÁLVULA

Empaques Adicionales





C.C. 999

5

FW6530035NR

RENAULT

HG6530035NR



CULATA

TAPA VÁLVULAS

CÁRTER

MÚLT. ADMISIÓN

MÚLT. ESCAPE

VS6530035

N/D

MI6530035

ME6530035

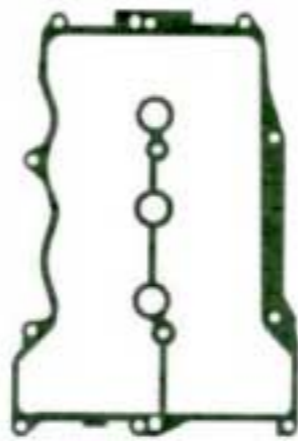

Gasolina

Calibre 1.0 mm.

Otras Juntas de Culata disponibles / HG6530035MLO / 910.034

MODELO	MOTOR	PISTON	AÑOS
KWID	B4D	Ø 71.00 mm.	2019 / 2023

DISTRIBUCIÓN

RETENEDORES

TUBO DE ESCAPE

TW6530035

N/D



SELLOS DE VÁLVULA

Empaques Adicionales





C.C. 1108

6

FW6540030

RENAULT

HG6540030SB

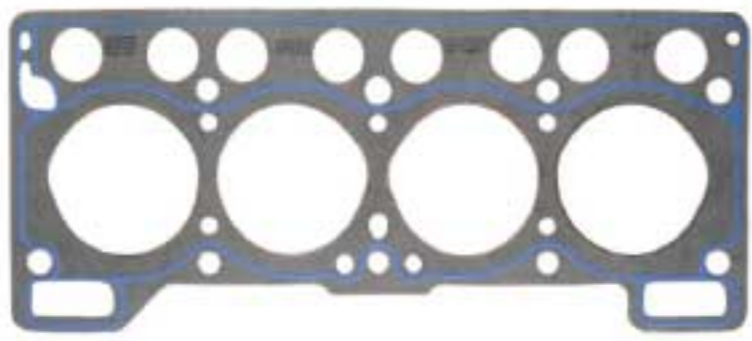

Gasolina

Calibre 1.3 mm.

CULATA

TAPA VÁLVULAS

CÁRTER

MÚLT. ADMISIÓN

MÚLT. ESCAPE

VS6540030

OS6540030

MS6540030

N/D

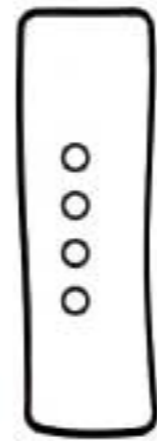

MODELO	MOTOR	PISTON	AÑOS
R4 PLUS	688	Ø 69.00 mm.	1976 / 1982
R6	688		1972 / 1975

DISTRIBUCIÓN

RETENEDORES

TUBO DE ESCAPE

N/D

N/D



SELLOS DE VÁLVULA

Empaques Adicionales





C.C. 1108

7

FS6540041

RENAULT

HG6540030SB



Gasolina

Calibre 1.3 mm.

CULATA TAPA VÁLVULAS CÁRTER MÚLT. ADMISIÓN MÚLT. ESCAPE

VS6540030

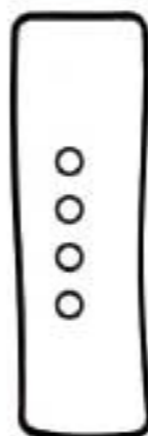

OS6540041



MS6540030



N/D

MODELO

MOTOR

PISTON

AÑOS

R4 MASTER

689

Ø 69.00 mm.

1976 / 1982

DISTRIBUCIÓN

N/D



RETENEDORES

Distribución
S030031P
30*42*8 mm



Eje de levas

Cigüeñal
S080021S
80*100*13 mm



TUBO DE ESCAPE

N/D

SELLOS DE VÁLVULA



SSJ4701P08

Ø Vástago 7 mm
Ø Guía 11 mm
Altura int. 7 mm
Altura ext. 10 mm

Empaques Adicionales





C.C. 1108

8

FW6540041

RENAULT

HG6540030SB

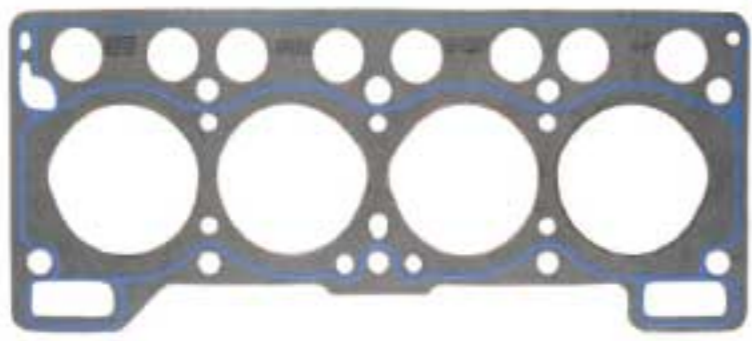

Gasolina

Calibre 1.3 mm.

CULATA

TAPA VÁLVULAS

CÁRTER

MÚLT. ADMISIÓN

MÚLT. ESCAPE

VS6540030

OS6540041

MS6540030

N/D

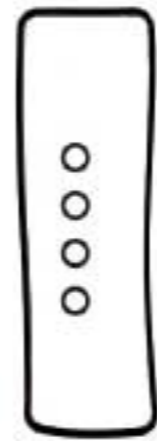

MODELO

MOTOR

PISTON

AÑOS

R4 MASTER

689

Ø 69.00 mm.

1976 / 1982

DISTRIBUCIÓN

RETENEDORES

TUBO DE ESCAPE

N/D

N/D



SELLOS DE VÁLVULA

Empaques Adicionales





C.C. 1149

9

FS6540045

RENAULT

HG6540045SB



CULATA **TAPA VÁLVULAS** **CÁRTER** **MÚLT. ADMISIÓN** **MÚLT. ESCAPE**

VS65400451

OS6540045

MI6540045

ME6540045

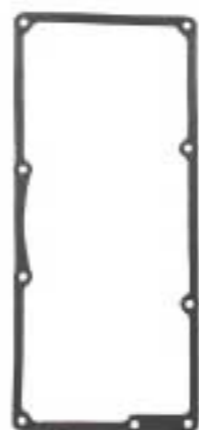

Gasolina

Calibre 1.3 mm.

Otras Juntas de Culata disponibles / HG6540045SM / HG6540045NR

MODELO	MOTOR	PISTON	AÑOS
TWINGO 8V	D7F	Ø 69.00 mm.	1996 / 1998

DISTRIBUCIÓN

N/D

RETENEDORES



Distribución
S030091P
30*42*7 mm



Eje de levas
S032041P
32*44*6 mm



Cigüeñal
S070071S
70*86*8 mm

TUBO DE ESCAPE

N/D

SELLOS DE VÁLVULA



SSJ2417V08

Ø Vástago 5.5 mm
Ø Guía 11 mm
Altura int. 15.3mm
Altura ext. 20 mm

Empaques Adicionales

VS6540048

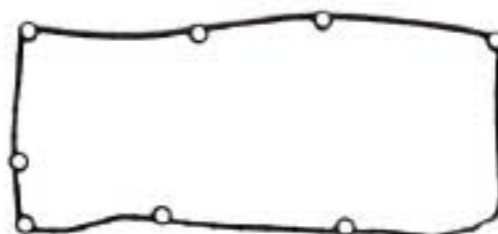
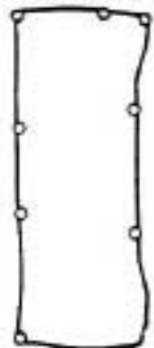



C.C. 1149

10

FS6540045ELRING

RENAULT

HG6540045SB



CULATA

TAPA VÁLVULAS

CÁRTER

MÚLT. ADMISIÓN

MÚLT. ESCAPE

VS65400451

OS6540045

MI6540045

ME6540045



Gasolina

Calibre 1.3 mm.

Otras Juntas de Culata disponibles / HG6540045SM / HG6540045NR

MODELO	MOTOR	PISTON	AÑOS
TWINGO 8V	D7F	Ø 69.00 mm.	1996 / 1998

DISTRIBUCIÓN

RETENEDORES

TUBO DE ESCAPE

N/D



Eje de levas
505.838
30*42*7 mm



Polea
050.540
32*44*6 mm



Cigüeñal
050.550
70*86*8 mm

N/D

SELLOS DE VÁLVULA



773.390

Ø Vástago 5.5 mm
Ø Guía 11 mm
Altura int. 15.3mm
Altura ext. 20 mm

Empaques Adicionales

VS6540048

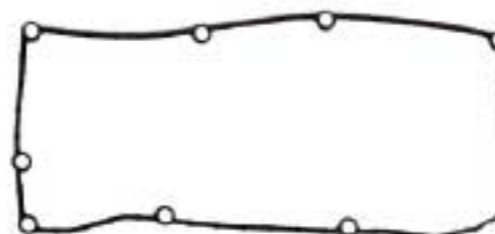
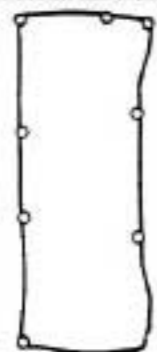



C.C. 1149

11

FW6540045

RENAULT

HG6540045SB



CULATA **TAPA VÁLVULAS** **CÁRTER** **MÚLT. ADMISIÓN** **MÚLT. ESCAPE**

VS65400451

OS6540045

MI6540045

ME6540045



Gasolina

Calibre 1.3 mm.

Otras Juntas de Culata disponibles / HG6540045SM / HG6540045NR

MODELO	MOTOR	PISTON	AÑOS
TWINGO 8V	D7F	Ø 69.00 mm.	1996 / 1998

DISTRIBUCIÓN

RETENEDORES

TUBO DE ESCAPE

N/D

N/D

SELLOS DE VÁLVULA

Empaques Adicionales

VS6540048

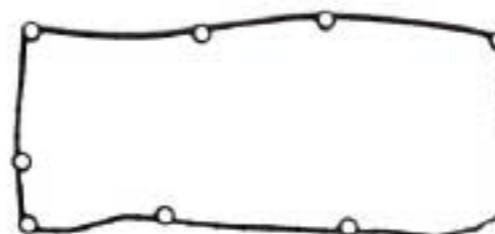
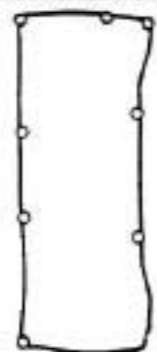



C.C. 1149

12

FS6540046

RENAULT

HG6540046MLO



CULATA

TAPA VÁLVULAS

CÁRTER

MÚLT. ADMISIÓN

MÚLT. ESCAPE

VS6540046



OS6540045



MI6540046



ME6540046



Gasolina

Otras Juntas de Culata disponibles / HG6540046SB / HG6540046SM

MODELO	MOTOR	PISTON	AÑOS
TWINGO 16V	D4F	Ø 69.00 mm.	2001 / 2013

DISTRIBUCIÓN

N/D

RETENEDORES



Distribución
S032041P
32*44*6 mm

Eje de levas



Cigüeñal
S070071S
70*86*8 mm

TUBO DE ESCAPE

N/D

SELLOS DE VÁLVULA



SSJ5803S16
Ø Vástago mm
Ø Guía mm
Altura int. mm
Altura ext. mm

Empaques Adicionales





C.C. 1149

13

FS6540047

RENAULT

HG6540046MLO



CULATA **TAPA VÁLVULAS** **CÁRTER** **MÚLT. ADMISIÓN** **MÚLT. ESCAPE**

VS65400471



OS6540045



MI6540046



ME6540046



Gasolina

MODELO	MOTOR	PISTON	AÑOS
CLIO CAMPUS	D4F	Ø 69.00 mm.	2001 / 2008
TWINGO 16V	D4F		2001 / 2013

DISTRIBUCIÓN

N/D

RETENEDORES



Distribución
S032041P
32*44*6 mm



Eje de levas
S028051P
28*47*8 mm



Cigüeñal
S070081P
70*86*7 mm

TUBO DE ESCAPE

N/D

SELLOS DE VÁLVULA



SSJ5803S16

Ø Vástago mm
Ø Guía mm
Altura int. mm
Altura ext. mm

Empaques Adicionales

RS6540047





C.C. 1149

14

FS6540047ELRING

RENAULT

HG6540046MLO



CULATA

TAPA VÁLVULAS

CÁRTER

MÚLT. ADMISIÓN

MÚLT. ESCAPE

VS65400471



OS6540045



MI6540046



ME6540046



Gasolina

MODELO	MOTOR	PISTON	AÑOS
CLIO CAMPUS	D4F	Ø 69.00 mm.	2001 / 2008
TWINGO 16V	D4F		2001 / 2013

DISTRIBUCIÓN

N/D

RETENEDORES

Polea
050.540
32*44*6 mm

Eje de levas
159.714
28*47*8 mm

Cigüeñal
050.550
70*86*8 mm

TUBO DE ESCAPE

N/D

SELLOS DE VÁLVULA

SSJ5803S16
Ø Vástago mm
Ø Guía mm
Altura int. mm
Altura ext. mm

Empaques Adicionales

RS6540047





C.C. 1149

15

FS6540047SB

RENAULT

HG6540046SB

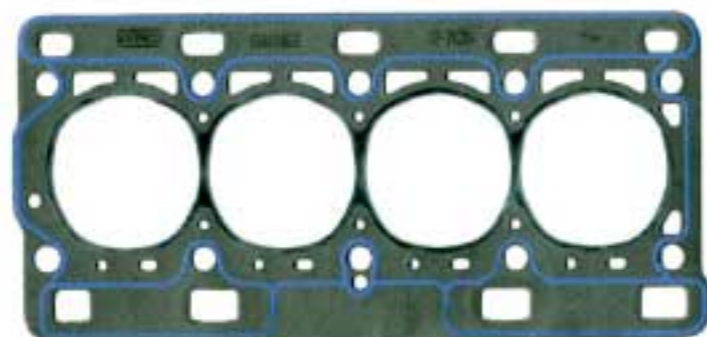

CULATA

TAPA VÁLVULAS

CÁRTER

MÚLT. ADMISIÓN

MÚLT. ESCAPE

VS65400471



OS6540045



MI6540046



ME6540046



Gasolina

Calibre 1.3 mm.

Otras Juntas de Culata disponibles / HG6540046SB / HG6540046SM

MODELO	MOTOR	PISTON	AÑOS
CLIO CAMPUS	D4F	Ø 69.00 mm.	2001 / 2008
TWINGO 16V	D4F		2001 / 2013

DISTRIBUCIÓN

N/D

RETENEDORES



Distribución
S032041P
32*44*6 mm



Eje de levas
S028051P
28*47*8 mm



Cigüeñal
S070081P
70*86*7 mm

TUBO DE ESCAPE

N/D

SELLOS DE VÁLVULA



SSJ5803S16

Ø Vástago mm
Ø Guía mm
Altura int. mm
Altura ext. mm

Empaques Adicionales





C.C. 1149

16

FW6540047SB

RENAULT

HG6540046SB

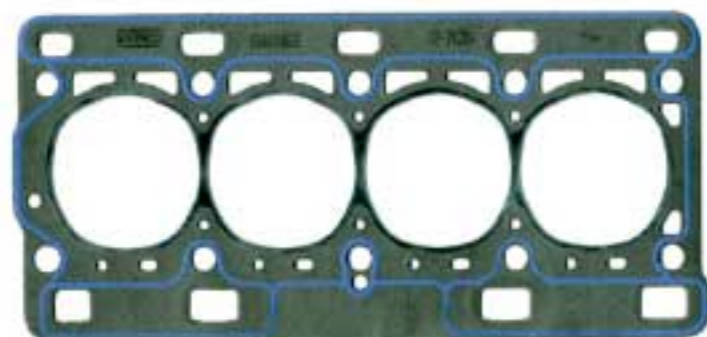

CULATA

TAPA VÁLVULAS

CÁRTER

MÚLT. ADMISIÓN

MÚLT. ESCAPE

VS65400471

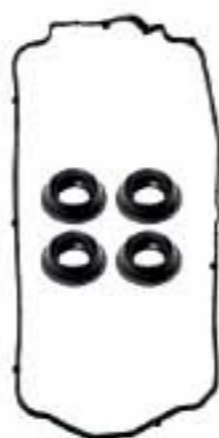

OS6540045



MI6540046



ME6540046



Gasolina

Calibre 1.3 mm.

Otras Juntas de Culata disponibles / HG6540046SB / HG6540046SM

MODELO	MOTOR	PISTON	AÑOS
CLIO CAMPUS	D4F	Ø 69.00 mm.	2001 / 2008
TWINGO 16V	D4F		2001 / 2013

DISTRIBUCIÓN

N/D

RETENEDORES

TUBO DE ESCAPE

N/D

SELLOS DE VÁLVULA

Empaques Adicionales





C.C. 1171

17

FS6540050

RENAULT

HG6540050SB

CULATA

TAPA VÁLVULAS

CÁRTER

MÚLT. ADMISIÓN

MÚLT. ESCAPE



Gasolina

Calibre 1.3 mm.

Otras Juntas de Culata disponibles / HG6540051SM

VS6540050

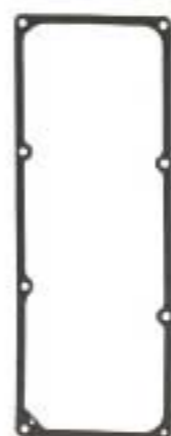

OS6540050



MI6540050



ME6540050



MODELO

MOTOR

PISTON

AÑOS

CLIO

E7F700-ENERGY

Ø 75.80 mm.

1990 / 1998

DISTRIBUCIÓN

N/D

RETENEDORES



Distribución
S030091P
30*42*7 mm



Eje de levas
S035021P
35*47*7 mm



Cigüeñal
S080051S
80*100*8.5 mm

TUBO DE ESCAPE

LA6540140



SELLOS DE VÁLVULA



SSJ5229V08

Ø Vástago 6 mm
Ø Guía 9.5 mm
Altura int. 7 mm
Altura ext. 10 mm

Empaques Adicionales





C.C. 1171

18

FW6540050

RENAULT

HG6540050SB

CULATA

TAPA VÁLVULAS

CÁRTER

MÚLT. ADMISIÓN

MÚLT. ESCAPE



VS6540050



OS6540050



MI6540050



ME6540050



Gasolina

Calibre 1.3 mm.

Otras Juntas de Culata disponibles / HG6540051SM

MODELO	MOTOR	PISTON	AÑOS
CLIO	E7F700-ENERGY	Ø 75.80 mm.	1990 / 1998

DISTRIBUCIÓN

N/D

RETENEDORES

TUBO DE ESCAPE

LA6540140



SELLOS DE VÁLVULA

Empaques Adicionales





C.C. 1239

19

FW6540095

RENAULT

HG6540095SB

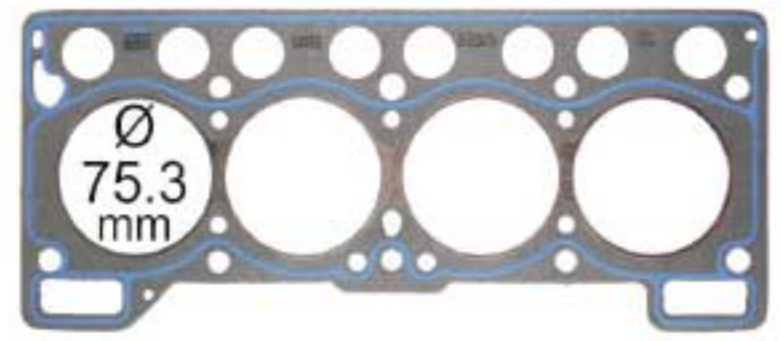

Gasolina

Calibre 1.6 mm.

Otras Juntas de Culata disponibles / HG6540095SM

CULATA **TAPA VÁLVULAS** **CÁRTER** **MÚLT. ADMISIÓN** **MÚLT. ESCAPE**

VS6540095

OS6540095

MS6540095

N/D



MODELO	MOTOR	PISTON	AÑOS
TWINGO	C3G	Ø 74.00 mm.	1992 / 1998

DISTRIBUCIÓN **RETENEDORES** **TUBO DE ESCAPE**

N/D

N/D

SELLOS DE VÁLVULA

Empaques Adicionales





C.C. 1289

20

FS6540090

RENAULT

HG6540090SB



Gasolina

Calibre 1.6 mm.

Otras Juntas de Culata disponibles / HG6540092SM

CULATA TAPA VÁLVULAS CÁRTER MÚLT. ADMISIÓN MÚLT. ESCAPE

VS6540030

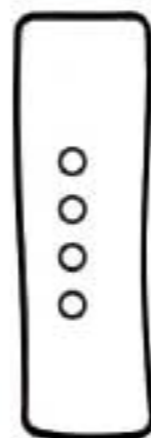

OS6540030



MS6540030



N/D

MODELO

MOTOR

PISTON

AÑOS

R12

810.03

Ø 73.00 mm.

1973 / 1984

DISTRIBUCIÓN

TC6540090



RETENEDORES



Distribución
S035031S
35*50*10 mm

Eje de levas
S0
mm



Cigüeñal
S070021S
70*90*10 mm

TUBO DE ESCAPE

LB6540090



SELLOS DE VÁLVULA



SSJ4701P08

Ø Vástago 7 mm
Ø Guía 11 mm
Altura int. 7 mm
Altura ext. 10 mm

Empaques Adicionales





C.C. 1289

21

FW6540090

RENAULT

HG6540090SB



Gasolina

Calibre 1.6 mm.

Otras Juntas de Culata disponibles / HG6540092SM

CULATA

TAPA VÁLVULAS

CÁRTER

MÚLT. ADMISIÓN

MÚLT. ESCAPE

VS6540030

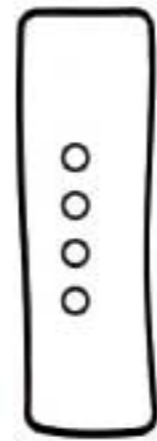

OS6540030



MS6540030



N/D

MODELO

MOTOR

PISTON

AÑOS

R12

810.03

Ø 73.00 mm.

1973 / 1984

DISTRIBUCIÓN

RETENEDORES

TUBO DE ESCAPE

TC6540090



LB6540090



SELLOS DE VÁLVULA

Empaques Adicionales





C.C. 1289

22

FS6540091

RENAULT

HG6540090SB



Gasolina

Calibre 1.6 mm.

Otras Juntas de Culata disponibles / HG6540092SM

CULATA TAPA VÁLVULAS CÁRTER MÚLT. ADMISIÓN MÚLT. ESCAPE

VS6540030

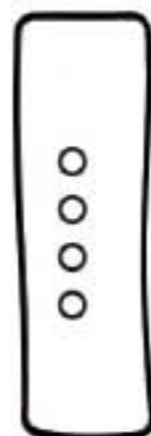

OS6540041



MS6540030



N/D

MODELO MOTOR PISTON AÑOS

R4 LIDER 810.19 Ø 73.00 mm. 1990 / 1992

DISTRIBUCIÓN

N/D



RETENEDORES



Distribución
S035031S
35*50*10 mm

TUBO DE ESCAPE

N/D



Cigüeñal
S080021S
80*100*13 mm

SELLOS DE VÁLVULA



Ø Vástago 7 mm
Ø Guía 11 mm
Altura int. 7 mm
Altura ext. 10 mm

Empaques Adicionales





C.C. 1289

23

FW6540091

RENAULT

HG6540090SB



Gasolina

Calibre 1.6 mm.

Otras Juntas de Culata disponibles / HG6540092SM

CULATA TAPA VÁLVULAS CÁRTER MÚLT. ADMISIÓN MÚLT. ESCAPE

VS6540030

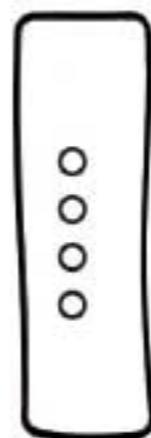

OS6540041



MS6540030



N/D

MODELO

MOTOR

PISTON

AÑOS

R4 LIDER

810.19

Ø 73.00 mm.

1990 / 1992

DISTRIBUCIÓN

RETENEDORES

TUBO DE ESCAPE

N/D



N/D

SELLOS DE VÁLVULA

Empaques Adicionales





C.C. 1289

24

FS6540092

RENAULT

HG6540090SB



Gasolina

Calibre 1.6 mm.

Otras Juntas de Culata disponibles / HG6540092SM

CULATA TAPA VÁLVULAS CÁRTER MÚLT. ADMISIÓN MÚLT. ESCAPE

VS6540030

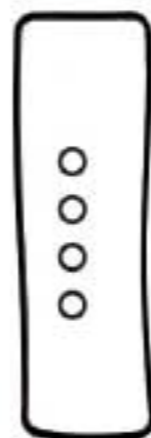

OS6540041



MS6540030



N/D

MODELO

MOTOR

PISTON

AÑOS

R6

810.02

Ø 73.00 mm.

1973 / 1984

DISTRIBUCIÓN

N/D



RETENEDORES

Distribución
S030031P
30*42*8 mm



Cigüeñal
S070021S
70*90*10 mm



TUBO DE ESCAPE

N/D

SELLOS DE VÁLVULA



Ø Vástago 7 mm
Ø Guía 11 mm
Altura int. 10.5 mm
Altura ext. 14 mm

Empaques Adicionales





C.C. 1289

25

FS6540093

RENAULT

HG6540090SB



Gasolina

Calibre 1.6 mm.

Otras Juntas de Culata disponibles / HG6540092SM

CULATA TAPA VÁLVULAS CÁRTER MÚLT. ADMISIÓN MÚLT. ESCAPE

VS6540030

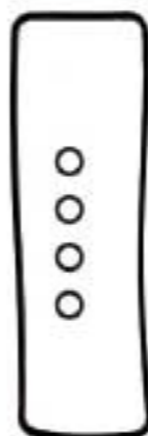

OS6540093



MS6540030



N/D

MODELO MOTOR PISTON AÑOS

R9 BRIO 810.05 Ø 73.00 mm. 1991 / 1996

DISTRIBUCIÓN

N/D



RETENEDORES



Distribución
S035031S
35*50*10 mm

Eje de levas
S0
mm



Cigüeñal
S080021S
80*100*13 mm

TUBO DE ESCAPE

LB6540090



SELLOS DE VÁLVULA



SSJ4701P08

Ø Vástago 7 mm
Ø Guía 11 mm
Altura int. 7 mm
Altura ext. 10 mm

Empaques Adicionales





C.C. 1289

26

FW6540093

RENAULT

HG6540090SB



Gasolina

Calibre 1.6 mm.

Otras Juntas de Culata disponibles / HG6540092SM

CULATA

TAPA VÁLVULAS

CÁRTER

MÚLT. ADMISIÓN

MÚLT. ESCAPE

VS6540030

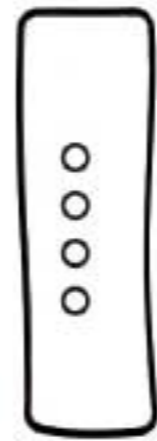

OS6540093



MS6540030



N/D

MODELO

MOTOR

PISTON

AÑOS

R9 BRIO

810.05

Ø 73.00 mm.

1991 / 1996

DISTRIBUCIÓN

RETENEDORES

TUBO DE ESCAPE

N/D



LB6540090



SELLOS DE VÁLVULA

Empaques Adicionales





C.C. 1289

27

FS6540094

RENAULT

HG6540090SB



Gasolina

Calibre 1.6 mm.

Otras Juntas de Culata disponibles / HG6540092SM

CULATA TAPA VÁLVULAS CÁRTER MÚLT. ADMISIÓN MÚLT. ESCAPE

VS6540030

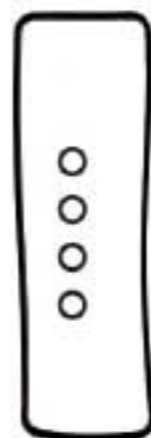

OS6540030



MS6540030



N/D

MODELO

MOTOR

PISTON

AÑOS

R4 PLUS

810

Ø 73.00 mm.

1976 / 1980

DISTRIBUCIÓN

N/D



RETENEDORES



Distribución
S035031S
35*50*10 mm

Eje de levas
S0
mm



Cigüeñal
S070021S
70*90*10 mm

TUBO DE ESCAPE

N/D

SELLOS DE VÁLVULA



SSJ4701P08

Ø Vástago 7 mm
Ø Guía 11 mm
Altura int. 7 mm
Altura ext. 10 mm

Empaques Adicionales





C.C. 1289

28

FW6540094

RENAULT

HG6540090SB



Gasolina

Calibre 1.6 mm.

Otras Juntas de Culata disponibles / HG6540092SM

CULATA

TAPA VÁLVULAS

CÁRTER

MÚLT. ADMISIÓN

MÚLT. ESCAPE

VS6540030

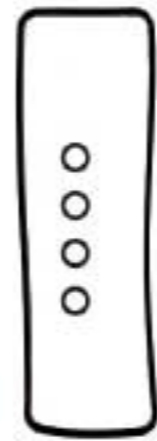

OS6540030



MS6540030



N/D

MODELO

MOTOR

PISTON

AÑOS

R4 PLUS

810

Ø 73.00 mm.

1976 / 1980

DISTRIBUCIÓN

RETENEDORES

TUBO DE ESCAPE

N/D



N/D

SELLOS DE VÁLVULA

Empaques Adicionales





C.C. 1390

29

FS6540050

RENAULT

HG6540050SB

CULATA

TAPA VÁLVULAS

CÁRTER

MÚLT. ADMISIÓN

MÚLT. ESCAPE



VS6540050



OS6540050



MI6540050



ME6540050



Gasolina

Calibre 1.3 mm.

Otras Juntas de Culata disponibles / HG6540051SM

MODELO	MOTOR	PISTON	AÑOS
CLIO	E7J700-ENERGY	Ø 79.50 mm.	1990 / 1998
EXPRESS	E7J700-ENERGY		1991 / 1997
R19	E7J700-ENERGY		1988 / 1990

DISTRIBUCIÓN

N/D

RETENEDORES



Distribución
S030091P
30*42*7 mm



Eje de levas
S035021P
35*47*7 mm



Cigüeñal
S080051S
80*100*8.5 mm

TUBO DE ESCAPE

LA6540140



SELLOS DE VÁLVULA



SSJ5229V08

Ø Vástago 6 mm
Ø Guía 9.5 mm
Altura int. 7 mm
Altura ext. 10 mm

Empaques Adicionales





C.C. 1390

30

FS6540050ELRING

RENAULT

HG6540050SB

CULATA

TAPA VÁLVULAS

CÁRTER

MÚLT. ADMISIÓN

MÚLT. ESCAPE



VS6540050



OS6540050



MI6540050



ME6540050



Gasolina

Calibre 1.3 mm.

Otras Juntas de Culata disponibles / HG6540051SM

MODELO	MOTOR	PISTON	AÑOS
CLIO	E7J700-ENERGY	Ø 79.50 mm.	1990 / 1998
EXPRESS	E7J700-ENERGY		1991 / 1997
R19	E7J700-ENERGY		1988 / 1990

DISTRIBUCIÓN

N/D

RETENEDORES



Distribución
505.838
30*42*7 mm



Eje de levas
504.483
35*47*7 mm



Cigüeñal
507.822
80*100*8 mm

TUBO DE ESCAPE

LA6540140



SELLOS DE VÁLVULA



701.289

Ø Vástago 6 mm
Ø Guía 9.5 mm
Altura int. 7 mm
Altura ext. 10 mm

Empaques Adicionales





C.C. 1390

31

FS6540050REL

RENAULT

HG6540050SB

CULATA

TAPA VÁLVULAS

CÁRTER

MÚLT. ADMISIÓN

MÚLT. ESCAPE



VS6540050



OS6540050



MI6540050



ME6540050



Gasolina

Calibre 1.3 mm.

Otras Juntas de Culata disponibles / HG6540051SM

MODELO	MOTOR	PISTON	AÑOS
CLIO	E7J700-ENERGY	Ø 79.50 mm.	1990 / 1998
EXPRESS	E7J700-ENERGY		1991 / 1997
R19	E7J700-ENERGY		1988 / 1990

DISTRIBUCIÓN

N/D

RETENEDORES



Distribución
505.838
30*42*7 mm



Eje de levas
504.483
35*47*7 mm



Cigüeñal
507.822
80*100*8 mm

TUBO DE ESCAPE

LA6540140



SELLOS DE VÁLVULA



SSJ5229V08

Ø Vástago 6 mm
Ø Guía 9.5 mm
Altura int. 7 mm
Altura ext. 10 mm

Empaques Adicionales





C.C. 1390

32

FS6540105

RENAULT

HG6540105MLO

CULATA

TAPA VÁLVULAS

CÁRTER

MÚLT. ADMISIÓN

MÚLT. ESCAPE



VS6540050



OS6540140



MI6540140



ME6540140



Gasolina

Otras Juntas de Culata disponibles / HG6540110GF / HG6540110SM

MODELO	MOTOR	PISTON	AÑOS
LOGAN	K7J710	Ø 79.50 mm.	2004 / 2016
SANDERO	K7J710		2009 / 2009

DISTRIBUCIÓN

N/D

RETENEDORES



Distribución
S035021P
35*47*7 mm



Eje de levas
S030091P
30*42*7 mm



Cigüeñal
S080051S
80*100*8.5 mm

TUBO DE ESCAPE

N/D

SELLOS DE VÁLVULA



SSJ5229V08

Ø Vástago 6 mm
Ø Guía 9.5 mm
Altura int. 7 mm
Altura ext. 10 mm

Empaques Adicionales





C.C. 1390

33

FS6540105ELRING

RENAULT

HG6540105MLO

CULATA

TAPA VÁLVULAS

CÁRTER

MÚLT. ADMISIÓN

MÚLT. ESCAPE



VS6540050



OS6540140



MI6540140



ME6540140



Gasolina

Otras Juntas de Culata disponibles / HG6540110GF / HG6540110SM

MODELO	MOTOR	PISTON	AÑOS
LOGAN	K7J710	Ø 79.50 mm.	2004 / 2016
SANDERO	K7J710		2009 / 2009

DISTRIBUCIÓN

N/D

RETENEDORES



Distribución
504.483
35*47*7 mm



Eje de levas
505.838
30*42*7 mm



Cigüeñal
507.822
80*100*8 mm

TUBO DE ESCAPE

N/D

SELLOS DE VÁLVULA



SSJ5229V08

Ø Vástago 6 mm
Ø Guía 9.5 mm
Altura int. 7 mm
Altura ext. 10 mm

Empaques Adicionales





C.C. 1390

34

FW6540105MLO

RENAULT

HG6540105MLO

CULATA

TAPA VÁLVULAS

CÁRTER

MÚLT. ADMISIÓN

MÚLT. ESCAPE



VS6540050



OS6540140



MI6540140



ME6540140



Gasolina

Otras Juntas de Culata disponibles / HG6540110GF / HG6540110SM

MODELO	MOTOR	PISTON	AÑOS
LOGAN	K7J710	Ø 79.50 mm.	2004 / 2016
SANDERO	K7J710		2009 / 2009

DISTRIBUCIÓN

N/D

RETENEDORES

TUBO DE ESCAPE

N/D

SELLOS DE VÁLVULA

Empaques Adicionales





C.C. 1390

35

FS6540108

RENAULT

HG6540109MLO

CULATA

TAPA VÁLVULAS

CÁRTER

MÚLT. ADMISIÓN

MÚLT. ESCAPE



Gasolina

N/D

OS6540109

MI6540109

ME6540109



MODELO

MOTOR

PISTON

AÑOS

CLIO II
MEGANE
SCENIC

K4J
K4J
K4J

Ø 79.50 mm.

1999 / 2009
1999 / 2006
1999 / 2003

DISTRIBUCIÓN

RETENEDORES

TUBO DE ESCAPE

N/D



Distribución
S035021P
35*47*7 mm



Eje de levas
S028041P
28*42*5 mm



Cigüeñal
S080071S
80*100*10 mm

N/D

SELLOS DE VÁLVULA



SSJ2406V16

Ø Vástago 4.5 mm
Ø Guía 11 mm
Altura int. 16.6 mm
Altura ext. 15.5 mm

Empaques Adicionales





C.C. 1390

36

FS6540109

RENAULT

HG6540109SB

CULATA

TAPA VÁLVULAS

CÁRTER

MÚLT. ADMISIÓN

MÚLT. ESCAPE



Gasolina

Calibre 1.3 mm.

Otras Juntas de Culata disponibles / HG6540109GF / HG6540109SM

N/D

OS6540109

MI6540109

ME6540109



MODELO

MOTOR

PISTON

AÑOS

CLIO II
MEGANE
SCENIC

K4J
K4J
K4J

Ø 79.50 mm.

1999 / 2009
1999 / 2006
1999 / 2003

DISTRIBUCIÓN

RETENEDORES

TUBO DE ESCAPE

N/D



Distribución
S035021P
35*47*7 mm



Eje de levas
S028041P
28*42*5 mm



Cigüeñal
S080071S
80*100*10 mm

N/D

SELLOS DE VÁLVULA



SSJ2406V16

Ø Vástago 4.5 mm
Ø Guía 11 mm
Altura int. 16.6 mm
Altura ext. 15.5 mm

Empaques Adicionales





C.C. 1390

37

FS6540109ELRING

RENAULT

HG6540109MLO

CULATA

TAPA VÁLVULAS

CÁRTER

MÚLT. ADMISIÓN

MÚLT. ESCAPE



Gasolina

N/D

OS6540109

MI6540109

ME6540109



MODELO

MOTOR

PISTON

AÑOS

CLIO II
MEGANE
SCENIC

K4J
K4J
K4J

Ø 79.50 mm.

1999 / 2009
1999 / 2006
1999 / 2003

DISTRIBUCIÓN

RETENEDORES

TUBO DE ESCAPE

N/D



Distribución
504.483
35*47*7 mm



Eje de levas
073.890
28*42*5 mm



Cigüeñal
507.822
80*100*8 mm

N/D

SELLOS DE VÁLVULA



SSJ2406V16

Ø Vástago 4.5 mm
Ø Guía 11 mm
Altura int. 16.6 mm
Altura ext. 15.5 mm

Empaques Adicionales





C.C. 1390

38

FS6540109ERSB

RENAULT

HG6540109SB

CULATA

TAPA VÁLVULAS

CÁRTER

MÚLT. ADMISIÓN

MÚLT. ESCAPE



Gasolina

Calibre 1.3 mm.

Otras Juntas de Culata disponibles / HG6540109GF / HG6540109SM

N/D

OS6540109

MI6540109

ME6540109



MODELO

MOTOR

PISTON

AÑOS

CLIO II
MEGANE
SCENIC

K4J
K4J
K4J

Ø 79.50 mm.

1999 / 2009
1999 / 2006
1999 / 2003

DISTRIBUCIÓN

RETENEDORES

TUBO DE ESCAPE

N/D



Distribución
504.483
35*47*7 mm



Eje de levas
073.890
28*42*5 mm



Cigüeñal
507.822
80*100*8 mm

N/D

SELLOS DE VÁLVULA



151.810

Ø Vástago 5.5 mm
Ø Guía 11 mm
Altura int. 13 mm
Altura ext. 16.3mm

Empaques Adicionales





C.C. 1390

39

FW6540109

RENAULT

HG6540109SB



CULATA

TAPA VÁLVULAS

CÁRTER

MÚLT. ADMISIÓN

MÚLT. ESCAPE

N/D

OS6540109

MI6540109

ME6540109



Gasolina

Calibre 1.3 mm.

Otras Juntas de Culata disponibles / HG6540109GF / HG6540109SM

MODELO	MOTOR	PISTON	AÑOS
CLIO II	K4J	Ø 79.50 mm.	1999 / 2009
MEGANE	K4J		1999 / 2006
SCENIC	K4J		1999 / 2003

DISTRIBUCIÓN

RETENEDORES

TUBO DE ESCAPE

N/D

N/D

SELLOS DE VÁLVULA

Empaques Adicionales

