



C.C. 4293

140

FS3062132

CHEVROLET

HG3062130NR - HG3062130NR

CULATA

TAPA VÁLVULAS

CÁRTER

MÚLT. ADMISIÓN

MÚLT. ESCAPE



VS3062132



OS3062135



MI3062132



ME3062130



Gasolina

Calibre 1.4 mm.

MODELO	MOTOR	PISTON	AÑOS
MINIBLAZER	262	Ø 101.60 mm.	1986 / 1990

DISTRIBUCIÓN

N/D



RETENEDORES



Distribución  
S044021P  
mm

Eje de levas  
S0  
mm

Cigüeñal  
S095021S  
95\*115\*12 mm



TUBO DE ESCAPE

LA3060010



SELLOS DE VÁLVULA



Ø Vástago 9.5 mm  
Ø Guía 13 mm  
Altura int.  
Altura ext. 13 mm

Empaques Adicionales





**C.C. 4293**

**141**

**FS3062136**

CHEVROLET

HG3062136NR - HG3062136NR

**CULATA**

**TAPA VÁLVULAS**

**CÁRTER**

**MÚLT. ADMISIÓN**

**MÚLT. ESCAPE**



VS3062136



OS3062136



MI3062136



ME3062130



**Gasolina**

Calibre 1.4 mm.

Otras Juntas de Culata disponibles / HG3062136ART

MODELO	MOTOR	PISTON	AÑOS
MINIBLAZER	262 VORTEC	Ø 101.60 mm.	1996 / 1999

**DISTRIBUCIÓN**

N/D

**RETENEDORES**

Distribución  
S0  
mm

Eje de levas  
S0  
mm



**Cigüeñal**  
S095021S  
95\*115\*12 mm

**TUBO DE ESCAPE**

N/D

**SELLOS DE VÁLVULA**



SSJ5237P12

Ø Vástago 8 mm  
Ø Guía 14 mm  
Altura int. 8.5 mm  
Altura ext. 12.5mm

**Empaques Adicionales**

MU3062136



MU3062137

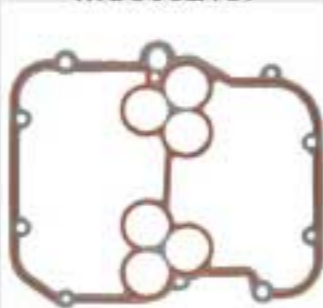



**C.C. 4293**

**142**

**FS3062138**

CHEVROLET

HG3062136NR - HG3062136NR

**CULATA**

**TAPA VÁLVULAS**

**CÁRTER**

**MÚLT. ADMISIÓN**

**MÚLT. ESCAPE**



VS3062136



OS3062138



MI3062138

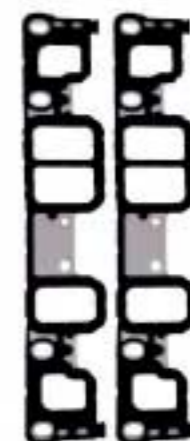

ME3062130



**Gasolina**

Calibre 1.4 mm.

Otras Juntas de Culata disponibles / HG3062136ART

MODELO	MOTOR	PISTON	AÑOS
EXPRESS 1500 SILVERADO 1500	262 VORTEC 262 VORTEC	Ø 101.60 mm.	2007 / 2011 2007 / 2011

**DISTRIBUCIÓN**

N/D

**RETENEDORES**



Distribución  
S044021P  
44.7\*61\*9.5

Eje de levas



Cigüeñal  
S095091  
PTFE

**TUBO DE ESCAPE**

N/D

**SELLOS DE VÁLVULA**



SSJ5237P12

Ø Vástago 8 mm  
Ø Guía 14 mm  
Altura int. 8.5 mm  
Altura ext. 12.5mm

**Empaques Adicionales**





C.C. 4343

143

FS3082051

CHEVROLET

HG3082051NR - HG3082051NR

CULATA

TAPA VÁLVULAS

CÁRTER

MÚLT. ADMISIÓN

MÚLT. ESCAPE



VS3082030



OS3082100



MI3082051

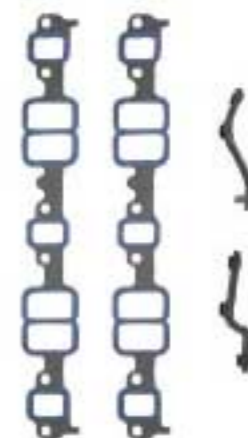

ME3082030



Gasolina

Calibre 1.4 mm.

Otras Juntas de Culata disponibles / HG3082051ART

MODELO	MOTOR	PISTON	AÑOS
BELAIR	265	Ø 95.25 mm.	1955 / 1957
CORVETTE	265		1955 / 1956

DISTRIBUCIÓN

N/D



RETENEDORES

Distribución  
S044021P  
44.8\*61.2\*9.7 mm

Eje de levas

Cigüeñal  
BS300404S



TUBO DE ESCAPE

LA3060010



SELLOS DE VÁLVULA

Ø Vástago  
Ø Guía  
Altura int.  
Altura ext.



Empaques Adicionales





C.C. 4570

144

FS3840240

CHEVROLET

HG3840240MLO

CULATA

TAPA VÁLVULAS

CÁRTER

MÚLT. ADMISIÓN

MÚLT. ESCAPE



VS3840240



OS3840240



MI3840240



ME3840240



Diesel

MODELO	MOTOR	PISTON	AÑOS
NPR	4HG1	Ø 115.00 mm.	2005 / 2010

DISTRIBUCIÓN

N/D

RETENEDORES



Distribución  
104\*139\*13 mm

Eje de levas



Cigüeñal  
109\*137\*13 mm

TUBO DE ESCAPE

N/D



SELLOS DE VÁLVULA



8 Sellos

Ø Vástago  
Ø Guía  
Altura int.  
Altura ext.

Empaques Adicionales

OS3840241





**C.C. 4638**

**145**

**FS3082051**

CHEVROLET

HG3082051NR - HG3082051NR

**CULATA**

**TAPA VÁLVULAS**

**CÁRTER**

**MÚLT. ADMISIÓN**

**MÚLT. ESCAPE**



VS3082030



OS3082100



MI3082051

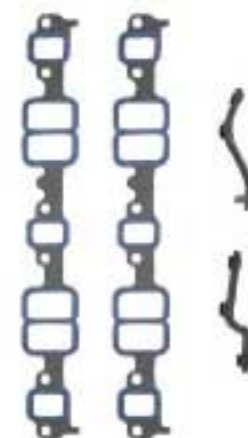

ME3082030



**Gasolina**

Calibre 1.4 mm.

Otras Juntas de Culata disponibles / HG3082051ART

MODELO	MOTOR	PISTON	AÑOS
BELAIR	283	Ø 98.40 mm.	1956 / 1957
BISCAYNE	283		1958 / 1967
CAPRICE	283		1966 / 1967
CHEVELLE	283		1964 / 1967
IMPALA	283		1958 / 1967
NOVA	283		1962 / 1967

**DISTRIBUCIÓN**

N/D



**RETENEDORES**

← Distribución  
S044021P  
44.8\*61.2\*9.7 mm

Eje de levas

← Cigüeñal  
BS300404S



**TUBO DE ESCAPE**

LA3060010



**SELLOS DE VÁLVULA**

← Ø Vástago  
Ø Guía  
Altura int.  
SSJ51123(12) Altura ext.



**Empaques Adicionales**





C.C. 4785

146

FS3060010

CHEVROLET

HG3060010SB

CULATA

TAPA VÁLVULAS

CÁRTER

MÚLT. ADMISIÓN

MÚLT. ESCAPE



VS3060010



OS3060010



MS3060010



N/D

Gasolina

Calibre 1.3 mm.

Otras Juntas de Culata disponibles / HG3060010ART

MODELO	MOTOR	PISTON	AÑOS
CAMIONETA S10	292	Ø 98.43 mm.	1963 / 1972
CAMIONETA S20	292		1963 / 1972
CAMIONETA S30	292		1963 / 1972

DISTRIBUCIÓN

TC3060010



RETENEDORES

Distribución  
S044021P  
44.8\*61.2\*9.7 mm

Eje de levas

Cigüeñal  
BS300404S

TUBO DE ESCAPE

LA3060010



SELLOS DE VÁLVULA

Ø Vástago  
Ø Guía  
Altura int.  
SSJ51122(12) Altura ext.

Empaques Adicionales

PS3060010



PS3060060





C.C. 4785

147

FS3060040

CHEVROLET

HG3060010SB

CULATA

TAPA VÁLVULAS

CÁRTER

MÚLT. ADMISIÓN

MÚLT. ESCAPE



VS3060040



OS3060040



MS3060040



N/D

Gasolina

Calibre 1.3 mm.

Otras Juntas de Culata disponibles / HG3060010ART

MODELO	MOTOR	PISTON	AÑOS
BLAZER	292	Ø 98.43 mm.	1979 / 1985
CAMIONETA S10	292		1979 / 1985
CAMIONETA S20	292		1979 / 1985

DISTRIBUCIÓN

N/D



RETENEDORES

Distribución  
S044021P  
44.8\*61.2\*9.7mm

Eje de levas

Cigüeñal  
BS300404P



TUBO DE ESCAPE

LA3060010



SELLOS DE VÁLVULA

Ø Vástago  
Ø Guía  
Altura int.  
Altura ext.  
SSJ51122(12)

Empaques Adicionales

PS3060010







C.C. 4807

148

FS3082065

CHEVROLET

HG3082065MLO - HG3082065MLO

CULATA

TAPA VÁLVULAS

CÁRTER

MÚLT. ADMISIÓN

MÚLT. ESCAPE

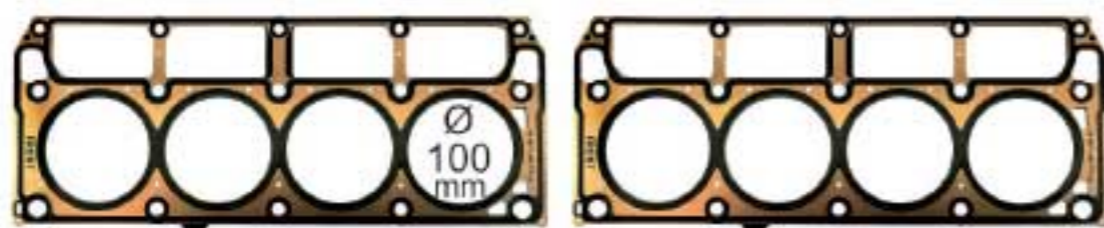

VS3082065

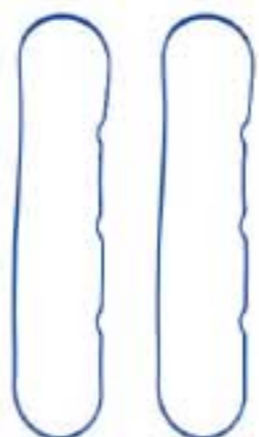

OS3082065



MI3082065



ME3082065



Gasolina

MODELO	MOTOR	PISTON	AÑOS
SILVERADO 2500 TAHOE	293 VORTEC 293 VORTEC	Ø 96.00 mm.	2007 / 2007 2007 / 2007

DISTRIBUCIÓN

N/D

RETENEDORES

TUBO DE ESCAPE

N/D

SELLOS DE VÁLVULA



SSJ2439P16

Ø Vástago 7.5 mm

Ø Guía 13 mm

Altura int.

Altura ext. 22.8mm

Empaques Adicionales





**C.C. 4807**

**149**

**FS3082066**

CHEVROLET

HG3082065NR - HG3082065NR

**CULATA**

**TAPA VÁLVULAS**

**CÁRTER**

**MÚLT. ADMISIÓN**

**MÚLT. ESCAPE**



VS3082065

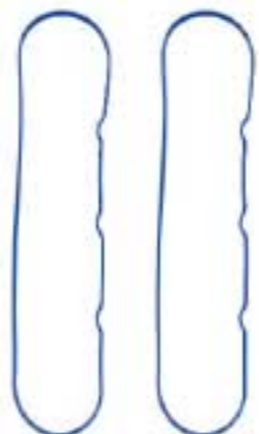

OS3082065



MI3082065



ME3082065



**Gasolina**

Calibre 1.4 mm.

Otras Juntas de Culata disponibles / HG3082065SM

MODELO	MOTOR	PISTON	AÑOS
SILVERADO 2500 TAHOE	293 VORTEC 293 VORTEC	Ø 96.00 mm.	2007 / 2007 2007 / 2007

**DISTRIBUCIÓN**

N/D

**RETENEDORES**

**TUBO DE ESCAPE**

N/D

**SELLOS DE VÁLVULA**



SSJ2439P16

Ø Vástago 7.5 mm  
Ø Guía 13 mm  
Altura int.  
Altura ext. 22.8mm

**Empaques Adicionales**



**C.C. 4807**

**150**

**FS3082067**

CHEVROLET

HG3082065MLO - HG3082065MLO

**CULATA**

**TAPA VÁLVULAS**

**CÁRTER**

**MÚLT. ADMISIÓN**

**MÚLT. ESCAPE**

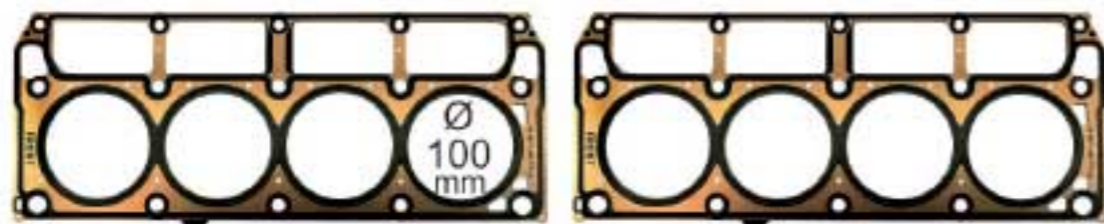

VS3082065

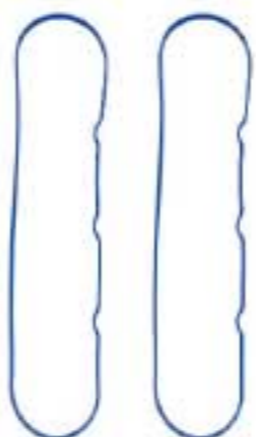

OS3082065



MI3082065



ME3082065



**Gasolina**

**MODELO**

**MOTOR**

**PISTON**

**AÑOS**

EXPRESS 2500	293 VORTEC	Ø 96.00 mm.	2008 / 2017
EXPRESS 3500	293 VORTEC		2008 / 2017
SILVERADO 1500	293 VORTEC		2008 / 2013
TAHOE	293 VORTEC		2008 / 2009

**DISTRIBUCIÓN**

N/D

**RETENEDORES**

**TUBO DE ESCAPE**

N/D

**SELLOS DE VÁLVULA**



SSJ2439P16

Ø Vástago 7.5 mm

Ø Guía 13 mm

Altura int.

Altura ext. 22.8mm

**Empaques Adicionales**

**C.C. 4807**

**151**

**FS3082067NR**

CHEVROLET

HG3082065NR - HG3082065NR

**CULATA**

**TAPA VÁLVULAS**

**CÁRTER**

**MÚLT. ADMISIÓN**

**MÚLT. ESCAPE**



VS3082065

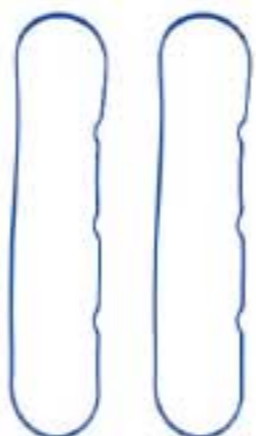

OS3082065



MI3082065



ME3082065



**Gasolina**

Calibre 1.4 mm.

Otras Juntas de Culata disponibles / HG3082065SM

MODELO	MOTOR	PISTON	AÑOS
EXPRESS 2500	293 VORTEC	Ø 96.00 mm.	2008 / 2017
EXPRESS 3500	293 VORTEC		2008 / 2017
SILVERADO 1500	293 VORTEC		2008 / 2013
TAHOE	293 VORTEC		2008 / 2009

**DISTRIBUCIÓN**

N/D

**RETENEDORES**

**TUBO DE ESCAPE**

N/D

**SELLOS DE VÁLVULA**



SSJ2439P16

Ø Vástago 7.5 mm  
 Ø Guía 13 mm  
 Altura int.  
 Altura ext. 22.8mm

**Empaques Adicionales**



C.C. 4949

152

FS3082051

CHEVROLET

HG3082051NR - HG3082051NR

CULATA

TAPA VÁLVULAS

CÁRTER

MÚLT. ADMISIÓN

MÚLT. ESCAPE



VS3082030



OS3082100



MI3082051

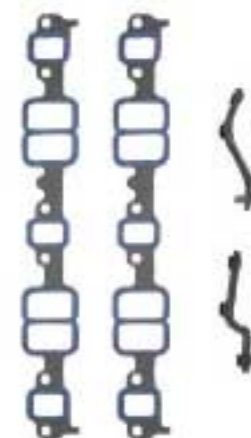

ME3082030



Gasolina

Calibre 1.4 mm.

Otras Juntas de Culata disponibles / HG3082051ART

MODELO	MOTOR	PISTON	AÑOS
CAMARO	302	Ø 101.60 mm.	1967 / 1969

DISTRIBUCIÓN

N/D



RETENEDORES

Distribución  
S044021P  
44.8\*61.2\*9.7 mm

Eje de levas

Cigüeñal  
BS300404S



TUBO DE ESCAPE

LA3060010



SELLOS DE VÁLVULA

Ø Vástago  
Ø Guía  
Altura int.  
Altura ext.



Empaques Adicionales





**C.C. 4998**

**153**

**FS3082100**

CHEVROLET

HG3082030NR - HG3082030NR

**CULATA**

**TAPA VÁLVULAS**

**CÁRTER**

**MÚLT. ADMISIÓN**

**MÚLT. ESCAPE**



VS3082030



OS3082100



MI3082160

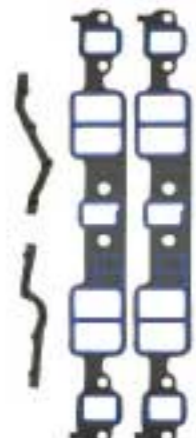

ME3082030



**Gasolina**

Calibre 1.4 mm.

Otras Juntas de Culata disponibles / HG3082030ART

MODELO	MOTOR	PISTON	AÑOS
CAMARO	305	Ø 94.89 mm.	1976 / 1978
CAMIONETA C10	305		1968 / 1973
CAPRICE	305		1976 / 1979
IMPALA	305		1976 / 1983

**DISTRIBUCIÓN**

N/D



**RETENEDORES**

Distribución  
S044021P  
44.8\*61.2\*9.7 mm

Eje de levas

Cigüeñal  
BS300404S



**TUBO DE ESCAPE**

LA3060010



**SELLOS DE VÁLVULA**

SSJ9509P16  
Ø Vástago 8 mm  
Ø Guía 13 mm  
Altura int. 8.5 mm  
Altura ext. 13 mm



**Empaques Adicionales**





**C.C. 4998**

**154**

**FS3082101**

CHEVROLET

HG3082030NR - HG3082030NR

**CULATA**

**TAPA VÁLVULAS**

**CÁRTER**

**MÚLT. ADMISIÓN**

**MÚLT. ESCAPE**



VS3082101



OS3082162



MI3082164



ME3082030



**Gasolina**

Calibre 1.4 mm.

Otras Juntas de Culata disponibles / HG3082030ART

MODELO	MOTOR	PISTON	AÑOS
BLAZER	305 Inj.	Ø 94.89 mm.	1987 / 1994
CAMIONETA C1500	305 Inj.		1988 / 1995
CAMIONETA C20	305 Inj.		1987 / 1998
CAMIONETA C2500	305 Inj.		1988 / 1995

**DISTRIBUCIÓN**

N/D



**RETENEDORES**

**Distribución**

S044021P  
44.8\*61.2\*9.7 mm

**Eje de levas**



**Cigüeñal**

S095021S  
95\*115\*12 mm

**TUBO DE ESCAPE**

LA3060010



**SELLOS DE VÁLVULA**



SSJ9509P16

Ø Vástago 8 mm  
Ø Guía 13 mm  
Altura int. 8.5 mm  
Altura ext. 13 mm

**Empaques Adicionales**





**C.C. 5031**

**155**

**FS3082051**

CHEVROLET

HG3082051NR - HG3082051NR

**CULATA**

**TAPA VÁLVULAS**

**CÁRTER**

**MÚLT. ADMISIÓN**

**MÚLT. ESCAPE**



VS3082030



OS3082100



MI3082051

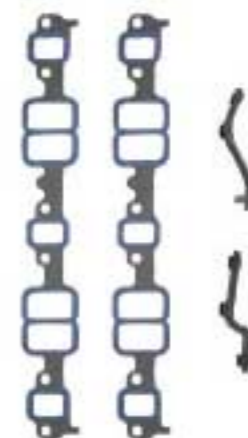

ME3082030



**Gasolina**

Calibre 1.4 mm.

Otras Juntas de Culata disponibles / HG3082051ART

MODELO	MOTOR	PISTON	AÑOS
BELAIR	307	Ø 98.40 mm.	1968 / 1968
BISCAYNE	307		1968 / 1968
CAMARO	307		1968 / 1973
CAPRICE	307		1968 / 1973
CHEVELLE	307		1968 / 1973
IMPALA	307		1968 / 1973
NOVA	307		1968 / 1973

**DISTRIBUCIÓN**

N/D



**RETENEDORES**

Distribución  
S044021P  
44.8\*61.2\*9.7 mm

Eje de levas

Cigüeñal  
BS300404S



**TUBO DE ESCAPE**

LA3060010



**SELLOS DE VÁLVULA**

Ø Vástago  
Ø Guía  
Altura int.  
Altura ext.



SSJ51123(12)

**Empaques Adicionales**







**C.C. 5328**

156

**FS3082065**

CHEVROLET

HG3082065MLO - HG3082065MLO

**CULATA**

**TAPA VÁLVULAS**

**CÁRTER**

**MÚLT. ADMISIÓN**

**MÚLT. ESCAPE**

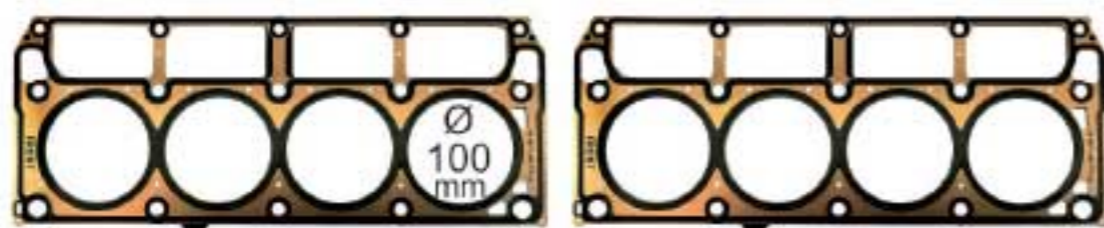

VS3082065

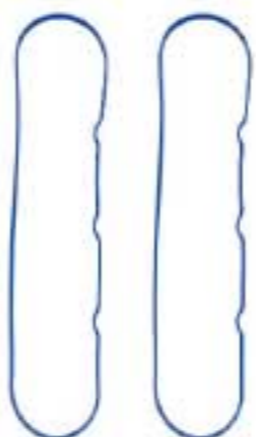

OS3082065



MI3082065



ME3082065



**Gasolina**

MODELO	MOTOR	PISTON	AÑOS
AVALANCHE	325 VORTEC	Ø 97.40 mm.	2007 / 2013
COLORADO	325 VORTEC		2009 / 2009
SILVERADO 1500	325 VORTEC		2005 / 2013
SUBURBAN	325 VORTEC		2007 / 2014
TAHOE	325 VORTEC		2007 / 2014
TRAILBLAZER	325 VORTEC		2006 / 2008

**DISTRIBUCIÓN**

N/D

**RETENEDORES**

**TUBO DE ESCAPE**

N/D

**SELLOS DE VÁLVULA**



SSJ2439P16

Ø Vástago 7.5 mm

Ø Guía 13 mm

Altura int.

Altura ext. 22.8mm

**Empaques Adicionales**





**C.C. 5328**

**157**

**FS3082066**

CHEVROLET

HG3082065NR - HG3082065NR

**CULATA**

**TAPA VÁLVULAS**

**CÁRTER**

**MÚLT. ADMISIÓN**

**MÚLT. ESCAPE**



VS3082065

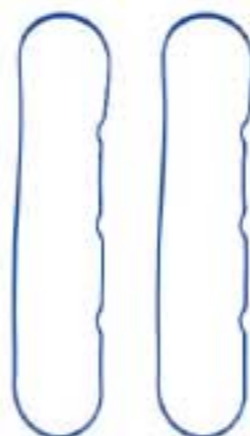

OS3082065



MI3082065



ME3082065



**Gasolina**

Calibre 1.4 mm.

Otras Juntas de Culata disponibles / HG3082065SM

MODELO	MOTOR	PISTON	AÑOS
AVALANCHE	325 VORTEC	Ø 97.40 mm.	2007 / 2013
COLORADO	325 VORTEC		2009 / 2009
SILVERADO 1500	325 VORTEC		2005 / 2013
SUBURBAN	325 VORTEC		2007 / 2014
TAHOE	325 VORTEC		2007 / 2014
TRAILBLAZER	325 VORTEC		2006 / 2008

**DISTRIBUCIÓN**

N/D

**RETENEDORES**

**TUBO DE ESCAPE**

N/D

**SELLOS DE VÁLVULA**



SSJ2439P16

Ø Vástago 7.5 mm

Ø Guía 13 mm

Altura int.

Altura ext. 22.8mm

**Empaques Adicionales**



**C.C. 5328**

**158**

**FS3082067**

CHEVROLET

HG3082065MLO - HG3082065MLO

**CULATA**

**TAPA VÁLVULAS**

**CÁRTER**

**MÚLT. ADMISIÓN**

**MÚLT. ESCAPE**

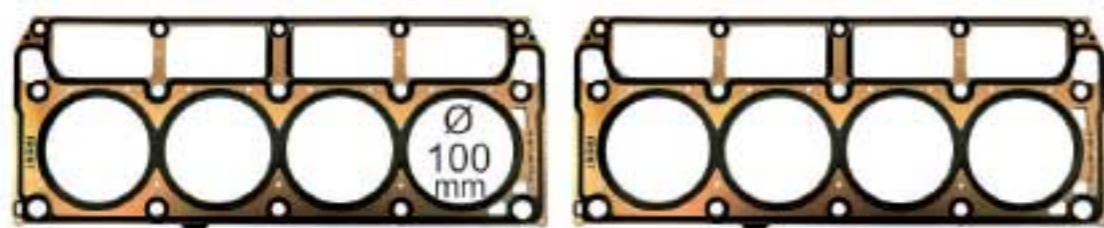

VS3082065

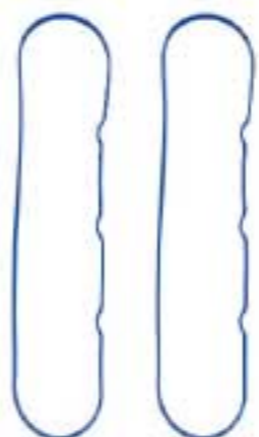

OS3082065



MI3082065



ME3082065



**Gasolina**

**MODELO**

**MOTOR**

**PISTON**

**AÑOS**

COLORADO  
EXPRESS 1500

325 VORTEC  
325 VORTEC

Ø 97.40 mm.

2009 / 2009  
2009 / 2014

**DISTRIBUCIÓN**

**RETENEDORES**

**TUBO DE ESCAPE**

N/D

N/D

**SELLOS DE VÁLVULA**



SSJ2439P16

Ø Vástago 7.5 mm

Ø Guía 13 mm

Altura int.

Altura ext. 22.8mm

**Empaques Adicionales**

**C.C. 5328**

**159**

**FS3082067NR**

CHEVROLET

HG3082065NR - HG3082065NR

**CULATA**

**TAPA VÁLVULAS**

**CÁRTER**

**MÚLT. ADMISIÓN**

**MÚLT. ESCAPE**



VS3082065

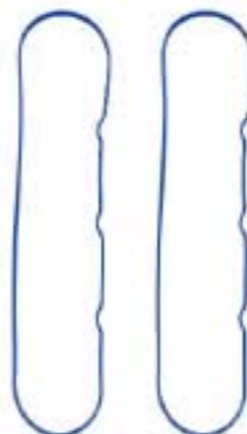

OS3082065



MI3082065



ME3082065



**Gasolina**

Calibre 1.4 mm.

Otras Juntas de Culata disponibles / HG3082065SM

MODELO	MOTOR	PISTON	AÑOS
COLORADO EXPRESS 1500	325 VORTEC 325 VORTEC	Ø 97.40 mm.	2009 / 2009 2009 / 2014

**DISTRIBUCIÓN**

N/D

**RETENEDORES**

**TUBO DE ESCAPE**

N/D

**SELLOS DE VÁLVULA**



SSJ2439P16

Ø Vástago 7.5 mm  
Ø Guía 13 mm  
Altura int.  
Altura ext. 22.8mm

**Empaques Adicionales**



**C.C. 5328**

**160**

**HG3082067NR**

CHEVROLET

HG3082067NR

**CULATA**

**TAPA VÁLVULAS**

**CÁRTER**

**MÚLT. ADMISIÓN**

**MÚLT. ESCAPE**

N/D

N/D

N/D

N/D



**Gasolina**

Calibre 1.4 mm.

MODELO	MOTOR	PISTON	AÑOS
SILVERADO	L8B	Ø 97.40 mm.	2014 / 2017
SUBURBAN	L8B		2015 / 2017
TAHOE	L8B		2015 / 2017

**DISTRIBUCIÓN**

**RETENEDORES**

**TUBO DE ESCAPE**

N/D

N/D

**SELLOS DE VÁLVULA**

**Empaques Adicionales**

LOS PRODUCTOS CON REFERENCIA SON DE VENTA POR SEPARADO



C.C. 5359

161

FS3082051

CHEVROLET

HG3082051NR - HG3082051NR

CULATA

TAPA VÁLVULAS

CÁRTER

MÚLT. ADMISIÓN

MÚLT. ESCAPE



VS3082030



OS3082100



MI3082051

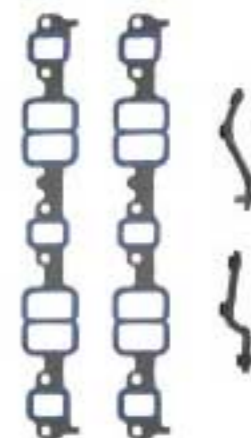

ME3082030



Gasolina

Calibre 1.4 mm.

Otras Juntas de Culata disponibles / HG3082051ART

MODELO	MOTOR	PISTON	AÑOS
BELAIR	327	Ø 101.60 mm.	2013 / 2020
BISCAYNE	327		1962 / 1969
CAMARO	327		1967 / 1969
CAPRICE	327		1966 / 1969
CHEVELLE	327		1964 / 1968
NOVA	327		1965 / 1968

DISTRIBUCIÓN

N/D



RETENEDORES

Distribución  
S044021P  
44.8\*61.2\*9.7 mm

Eje de levas

Cigüeñal  
BS300404S



TUBO DE ESCAPE

LA3060010



SELLOS DE VÁLVULA

Ø Vástago  
Ø Guía  
Altura int.  
Altura ext.



SSJ51123(12)

Empaques Adicionales





**C.C. 5735**

**162**

**FS3082160**

CHEVROLET

HG3082051NR - HG3082051NR

**CULATA**

**TAPA VÁLVULAS**

**CÁRTER**

**MÚLT. ADMISIÓN**

**MÚLT. ESCAPE**



VS3082030



OS3082100



MI3082160



ME3082030



**Gasolina**

Calibre 1.4 mm.

Otras Juntas de Culata disponibles / HG3082051ART

MODELO	MOTOR	PISTON	AÑOS
BLAZER	350	Ø 101.60 mm.	1969 / 1985
CAMIONETA C10	350		1969 / 1985
CAMIONETA C20	350		1969 / 1985
CAMIONETA C30	350		1969 / 1985

**DISTRIBUCIÓN**

N/D



**RETENEDORES**

← Distribución  
S044021P  
44.8\*61.2\*9.7 mm

Eje de levas

↪ Cigüeñal  
BS300404S

**TUBO DE ESCAPE**

LA3060010



**SELLOS DE VÁLVULA**

SSJ9509P16  
Ø Vástago 8 mm  
Ø Guía 13 mm  
Altura int. 8.5 mm  
Altura ext. 13 mm

**Empaques Adicionales**





C.C. 5735

163

FS3082162

CHEVROLET

HG3082051NR - HG3082051NR

CULATA

TAPA VÁLVULAS

CÁRTER

MÚLT. ADMISIÓN

MÚLT. ESCAPE



VS3082030



OS3082162



MI3082160



ME3082030



Gasolina

Calibre 1.4 mm.

Otras Juntas de Culata disponibles / HG3082051ART

MODELO	MOTOR	PISTON	AÑOS
CAMIONETA C30	350	Ø 101.60 mm.	1969 / 1985

DISTRIBUCIÓN

N/D



RETENEDORES

Distribución  
S044021P  
44.8\*61.2\*9.7 mm

Eje de levas

Cigüeñal  
S095021S  
95\*115\*12 mm



TUBO DE ESCAPE

LA3060010



SELLOS DE VÁLVULA

SSJ9509P16  
Ø Vástago 8 mm  
Ø Guía 13 mm  
Altura int. 8.5 mm  
Altura ext. 13 mm

Empaques Adicionales







C.C. 5735

164

FS3082164

CHEVROLET

HG3082051NR - HG3082051NR

CULATA

TAPA VÁLVULAS

CÁRTER

MÚLT. ADMISIÓN

MÚLT. ESCAPE



VS3082164



OS3082162



MI3082164

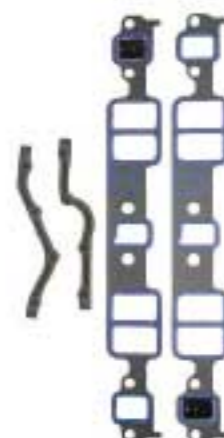

ME3082030



Gasolina

Calibre 1.4 mm.

Otras Juntas de Culata disponibles / HG3082051ART

MODELO	MOTOR	PISTON	AÑOS
BLAZER C2500	350 350	Ø 101.60 mm.	1969 / 1985 1988 / 1995

DISTRIBUCIÓN

N/D



RETENEDORES

Distribución  
S044021P  
44.8\*61.2\*9.7 mm

Eje de levas

Cigüeñal  
S095021S  
95\*115\*12 mm



TUBO DE ESCAPE

LA3060010



SELLOS DE VÁLVULA

SSJ9509P16  
Ø Vástago 8 mm  
Ø Guía 13 mm  
Altura int. 8.5 mm  
Altura ext. 13 mm



Empaques Adicionales





**C.C. 5735**

**165**

**FS3082167**

CHEVROLET

HG3082051NR - HG3082051NR

**CULATA**

**TAPA VÁLVULAS**

**CÁRTER**

**MÚLT. ADMISIÓN**

**MÚLT. ESCAPE**



VS3082164



OS3082162



MI3082167

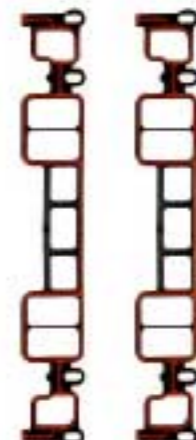

ME3082167



**Gasolina**

Calibre 1.4 mm.

Otras Juntas de Culata disponibles / HG3082051ART

MODELO	MOTOR	PISTON	AÑOS
C1500	350 VORTEC	Ø 101.60 mm.	1996 / 1999
C2500	350 VORTEC		1996 / 2000
CHEYENNE	350 VORTEC		1996 / 2000
P30	350 VORTEC		1996 / 1999
SILVERADO 2500	350 VORTEC		1996 / 2000

**DISTRIBUCIÓN**

N/D

**RETENEDORES**

Distribución

Eje de levas



**Cigüeñal**

S095021S

95\*115\*12 mm

**TUBO DE ESCAPE**

N/D

**SELLOS DE VÁLVULA**



Ø Vástago 8 mm

Ø Guía 14 mm

Altura int. 8.5 mm

SSJ5237P16 Altura ext. 12 mm

**Empaques Adicionales**

MU3082167





C.C. 5967

166

FS3082172

CHEVROLET

HG3082172MLO - HG3082172MLO

CULATA

TAPA VÁLVULAS

CÁRTER

MÚLT. ADMISIÓN

MÚLT. ESCAPE



VS3082065

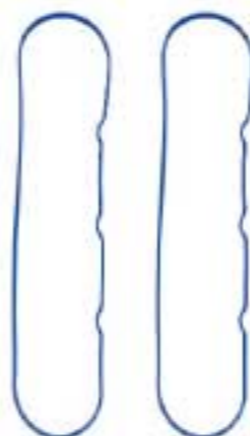

OS3082065



MI3082065



ME3082065



Gasolina

MODELO	MOTOR	PISTON	AÑOS
EXPRESS 2500	364 LQ4	Ø 101.60 mm.	2004 / 2007
EXPRESS 3500	364 LQ4		2004 / 2007
SILVERADO 1500	364 LQ4		2004 / 2007
SILVERADO 2500	364 LQ4		2004 / 2007
SILVERADO 3500	364 LQ4		2004 / 2007
SUBURBAN 1500	364 LQ4		2006 / 2006
SUBURBAN 2500	364 LQ4		2004 / 2006

DISTRIBUCIÓN

N/D

RETENEDORES

TUBO DE ESCAPE

N/D

SELLOS DE VÁLVULA



SSJ2439P16

Ø Vástago 7.5 mm

Ø Guía 13 mm

Altura int. mm

Altura ext. 22.8mm

Empaques Adicionales





C.C. 5967

167

FS3082172NR

CHEVROLET

HG3082172NR - HG3082172NR

CULATA

TAPA VÁLVULAS

CÁRTER

MÚLT. ADMISIÓN

MÚLT. ESCAPE



VS3082065

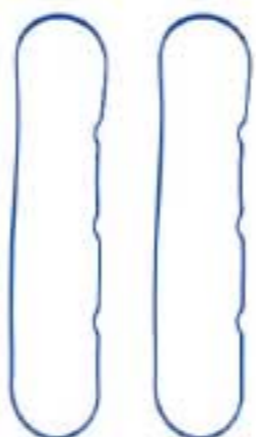

OS3082065



MI3082065



ME3082065



Gasolina

Calibre 1.4 mm.

Otras Juntas de Culata disponibles / HG3082172ART

MODELO	MOTOR	PISTON	AÑOS
EXPRESS 2500	364 LQ4	Ø 101.60 mm.	2004 / 2007
EXPRESS 3500	364 LQ4		2004 / 2007
SILVERADO 1500	364 LQ4		2004 / 2007
SILVERADO 2500	364 LQ4		2004 / 2007
SILVERADO 3500	364 LQ4		2004 / 2007
SUBURBAN 1500	364 LQ4		2006 / 2006
SUBURBAN 2500	364 LQ4		2004 / 2006

DISTRIBUCIÓN

N/D

RETENEDORES

TUBO DE ESCAPE

N/D

SELLOS DE VÁLVULA



SSJ2439P16

Ø Vástago 7.5 mm

Ø Guía 13 mm

Altura int. mm

Altura ext. 22.8mm

Empaques Adicionales





C.C. 5967

168

FS3082173

CHEVROLET

HG3082173MLO - HG3082173MLO

CULATA

TAPA VÁLVULAS

CÁRTER

MÚLT. ADMISIÓN

MÚLT. ESCAPE



VS3082065

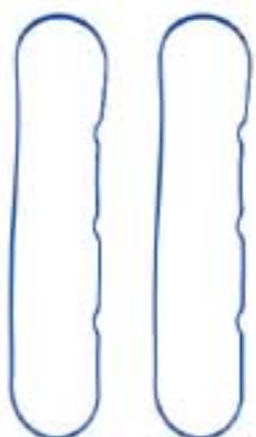

OS3082065



MI3082065



ME3082065



Gasolina

MODELO	MOTOR	PISTON	AÑOS
EXPRESS 2500	364 LQ4	Ø 101.60 mm.	2004 / 2007
EXPRESS 3500	364 LQ4		2004 / 2007
EXPRESS 4500	364 LQ4		2010 / 2020
SILVERADO 2500	364 LQ4		2004 / 2007
SILVERADO 3500	364 LQ4		2004 / 2007
SUBURBAN 2500	364 LQ4		2004 / 2006
SUBURBAN 3500	364 LQ4		2016 / 2019

DISTRIBUCIÓN

N/D

RETENEDORES

TUBO DE ESCAPE

N/D

SELLOS DE VÁLVULA



SSJ2439P16

Ø Vástago 7.5 mm

Ø Guía 13 mm

Altura int. mm

Altura ext. 22.8mm

Empaques Adicionales





C.C. 5998

169

FS3082230

CHEVROLET

HG3082230NR - HG3082230NR

CULATA

TAPA VÁLVULAS

CÁRTER

MÚLT. ADMISIÓN

MÚLT. ESCAPE



VS3082180



OS3082180



MI3082180

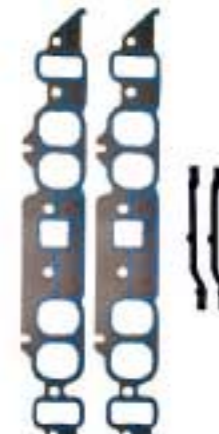

ME3082180



Gasolina

Calibre 1.4 mm.

MODELO	MOTOR	PISTON	AÑOS
B60	366	Ø 104.00 mm.	1966 / 1990

DISTRIBUCIÓN

TC3082180



RETENEDORES

Distribución  
S059021P  
59.2\*76.2\*10 mm

Eje de levas

Cigüeñal  
BS301804S

TUBO DE ESCAPE

LA3082180



SELLOS DE VÁLVULA

SSJ9510P16  
Ø Vástago 9.5 mm  
Ø Guía 15.5 mm  
Altura int. 10 mm  
Altura ext. 15 mm

Empaques Adicionales





C.C. 5998

170

FS3082252

CHEVROLET

HG3082081NR - HG3082081NR

CULATA

TAPA VÁLVULAS

CÁRTER

MÚLT. ADMISIÓN

MÚLT. ESCAPE



Gasolina

Calibre 1.4 mm.

VS3082081

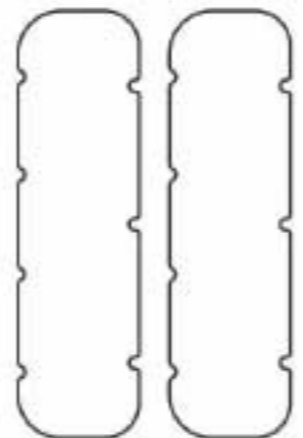

OS3082081



MI3082081



ME3082180



MODELO

MOTOR

PISTON

AÑOS

KODIAK B60

366

Ø 104.00 mm.

1991 / 1996

DISTRIBUCIÓN

TC3082180



RETENEDORES

Distribución  
S059021P  
59.2\*76.2\*10 mm

Eje de levas

Cigüeñal  
S100011S  
100\*130\*10 mm

TUBO DE ESCAPE

LA2274



SELLOS DE VÁLVULA

SSJ9510P16  
Ø Vástago 9.5 mm  
Ø Guía 15.5 mm  
Altura int. 10 mm  
Altura ext. 15 mm

Empaques Adicionales





C.C. 6162

171

FS3082173

CHEVROLET

HG3082173MLO - HG3082173MLO

CULATA

TAPA VÁLVULAS

CÁRTER

MÚLT. ADMISIÓN

MÚLT. ESCAPE



VS3082065

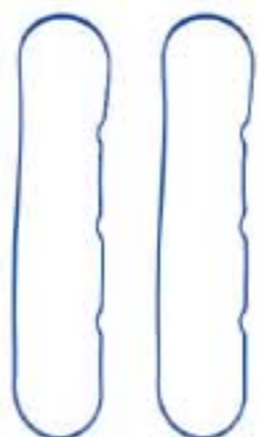

OS3082065



MI3082065



ME3082065



Gasolina

MODELO	MOTOR	PISTON	AÑOS
SILVERADO 1500 TAHOE	376 VORTEC 376 VORTEC	Ø 101.60 mm.	2009 / 2013 2009 / 2009

DISTRIBUCIÓN

N/D

RETENEDORES

TUBO DE ESCAPE

N/D

SELLOS DE VÁLVULA



SSJ2439P16

Ø Vástago 7.5 mm  
Ø Guía 13 mm  
Altura int. mm  
Altura ext. 22.8mm

Empaques Adicionales







C.C. 6489

172

FS3082180

CHEVROLET

HG3082180NR - HG3082180NR

CULATA

TAPA VÁLVULAS

CÁRTER

MÚLT. ADMISIÓN

MÚLT. ESCAPE



Gasolina

Calibre 1.4 mm.

VS3082180



OS3082180



MI3082180

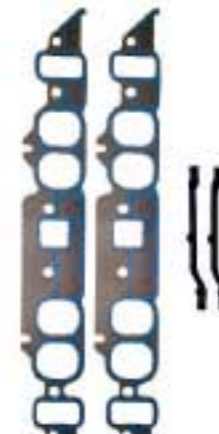

ME3082180



MODELO

MOTOR

PISTON

AÑOS

C10  
C20  
C30

396  
396  
396

Ø 104.00 mm.

1968 / 1969  
1968 / 1969  
1968 / 1969

DISTRIBUCIÓN

TC3082180



RETENEDORES

← Distribución  
S059021P  
59.2\*76.2\*10 mm

Eje de levas

⌋ Cigüeñal  
BS301804S

TUBO DE ESCAPE

LA3082180



SELLOS DE VÁLVULA

SSJ9505P16  
Ø Vástago 11 mm  
Ø Guía 16 mm  
Altura int. 9 mm  
Altura ext. 14 mm

Empaques Adicionales

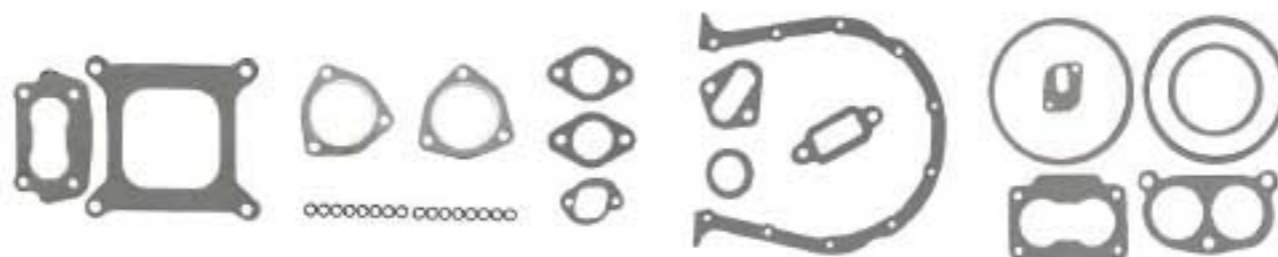



C.C. 6997

173

FS3082253

CHEVROLET

HG3082252NR - HG3082252NR

CULATA

TAPA VÁLVULAS

CÁRTER

MÚLT. ADMISIÓN

MÚLT. ESCAPE



VS3082081

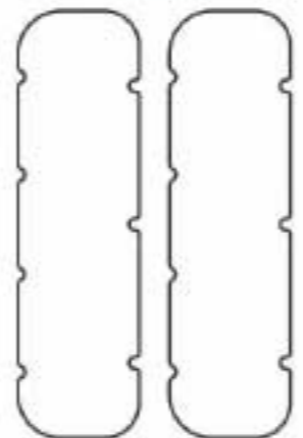

OS3082081



MI3082180

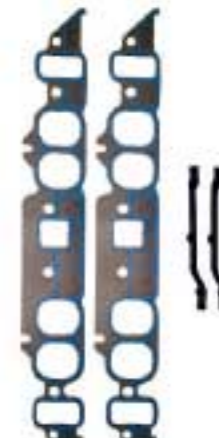

ME3082180



Gasolina

MODELO	MOTOR	PISTON	AÑOS
BELAIR	427	Ø 108.00 mm.	1966 / 1969

DISTRIBUCIÓN

TC3082180



RETENEDORES

Distribución  
S059021P  
59.2\*76.2\*10 mm

Eje de levas

Cigüeñal  
S100011S  
100\*130\*10 mm

TUBO DE ESCAPE

LA3082180



SELLOS DE VÁLVULA

SSJ9510P16  
Ø Vástago 9.5 mm  
Ø Guía 15.5 mm  
Altura int. 10 mm  
Altura ext. 15 mm

Empaques Adicionales





C.C. 6997

174

FS3082261

CHEVROLET

HG3082052NR - HG3082052NR

CULATA

TAPA VÁLVULAS

CÁRTER

MÚLT. ADMISIÓN

MÚLT. ESCAPE



VS3082081

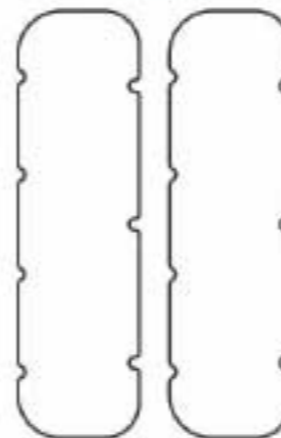

OS3082081



MI3082081



ME3082180



Gasolina

Calibre 1.4 mm.

MODELO	MOTOR	PISTON	AÑOS
KODIAK C70	427	Ø 108.00 mm.	1991 / 1995

DISTRIBUCIÓN

TC3082180



RETENEDORES



Distribución  
S059021P  
59\*76\*10 mm

Eje de levas  
S0  
mm

Cigüeñal

S100011S  
110\*130\*10 mm



TUBO DE ESCAPE

LA2274



SELLOS DE VÁLVULA



Ø Vástago 9.5 mm  
Ø Guía 15.5 mm  
Altura int. 10 mm  
Altura ext. 15 mm

Empaques Adicionales





**C.C. 7127**

**175**

**HG3860080MLO**

CHEVROLET

HG3860080MLO

**CULATA**

**TAPA VÁLVULAS**

**CÁRTER**

**MÚLT. ADMISIÓN**

**MÚLT. ESCAPE**

N/D

N/D

N/D

N/D



**Diesel**

**MODELO**

**MOTOR**

**PISTON**

**AÑOS**

FTR

6HE1

Ø 110.00 mm.

2005 / 2009

**DISTRIBUCIÓN**

**RETENEDORES**

**TUBO DE ESCAPE**

N/D

N/D

**SELLOS DE VÁLVULA**

**Empaques Adicionales**

LOS PRODUCTOS CON REFERENCIA SON DE VENTA POR SEPARADO